

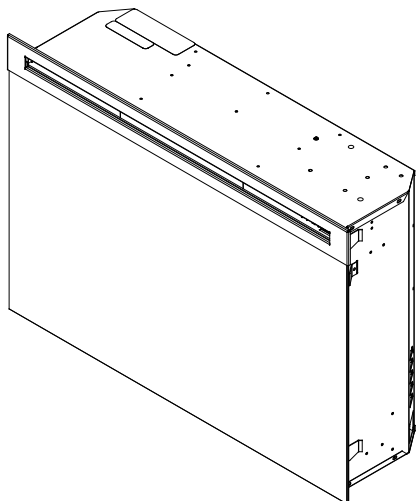

Better solutions through innovation



Owner's Manual

Model
DFG3033







IMPORTANT SAFETY INFORMATION: Always read this manual first before attempting to install or use this fireplace. For your safety, always comply with all warnings and safety instructions contained in this manual to prevent personal injury or property damage.

To view the full line of Dimplex products, please visit
www.dimplex.com

7210600100R08



Table of Contents

 Welcome & Congratulations	3
 Important Instructions	4
 Fireplace Installation	7
 Operation	10
 Maintenance.	16
 Warranty	17
 Replacement Parts List	20

Always use a qualified technician or service agency to repair this fireplace.

! NOTE: Procedures and techniques that are considered important enough to emphasize.

⚠ CAUTION: Procedures and techniques which, if not carefully followed, will result in damage to the equipment.

⚠ WARNING: Procedures and techniques which, if not carefully followed, will expose the user to the risk of fire, serious injury, or death.

Welcome & Congratulations

Thank you and congratulations for choosing to purchase an electric fireplace from Dimplex, the world leader in electric fireplaces.

Please carefully read and save these instructions.

⚠ CAUTION: Read all instructions and warnings carefully before starting installation. Failure to follow these instructions may result in a possible electric shock, fire hazard and will void the warranty.

Please record your model and serial numbers below for future reference: model and serial numbers can be found on the Model and Serial Number Label of your fireplace.

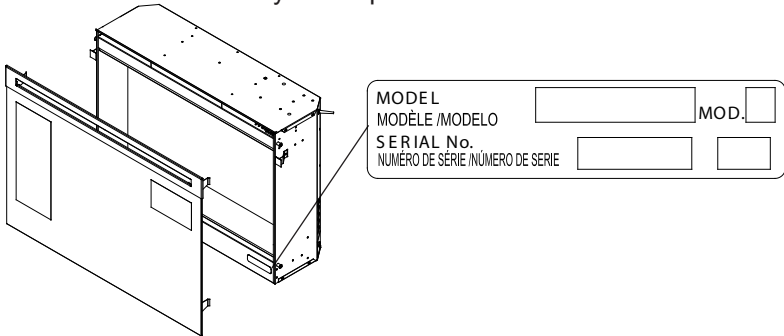

STOP NO NEED TO RETURN TO THE STORE

Questions with operation or assembly? Require Parts Information?
Product Under Manufacturer's Warranty?

Contact us at:  www.dimplex.com/customer_support
For Troubleshooting and Technical Support

OR  **Toll-Free 1-888-DIMPLEX (1-888-346-7539)**
Monday to Friday 8:00 a.m. to 4:30 p.m. EST
Please have your model number and product serial number ready. (See above)



IMPORTANT INSTRUCTIONS

When using electrical appliances, basic precautions should always be followed to reduce the risk of fire, electric shock, and injury to persons, including the following:

- ① Read all instructions before using the electric fireplace.
- ② The heater is hot when in use. To avoid burns, do not let bare skin touch hot surfaces. The trim around the heater outlet becomes hot during heater operation.
- ③ Extreme caution is necessary when any heater is used by or near children or invalids and whenever the unit is left operating and unattended.
- ④ Always unplug the electric fireplace when not in use.
- ⑤ Do not operate any heater after it malfunctions. Disconnect power at the service panel and have the heater inspected by a reputable electrician before reusing.
- ⑥ Do not operate any unit with a damaged cord or plug, or if the heater has malfunctioned, or if the electric fireplace has been dropped or damaged in any manner, contact Dimplex Technical Service at 1-888-346-7539.
- ⑦ Do not use outdoors.
- ⑧ The electric fireplace is not intended for use in bathrooms, laundry areas and similar indoor locations. Never locate heater where it may fall into a bathtub or other water container.
- ⑨ Do not run the cord under carpeting. Do not cover cord with throw rugs, runners, or the like. Arrange cord away from traffic area and where it will not be tripped over.
- ⑩ To disconnect the unit, turn the controls off, then remove the plug from the outlet.
- ⑪ Do not insert or allow foreign objects to enter any ventilation or exhaust opening as this may cause an electric shock or fire, or damage to the heater.
- ⑫ To prevent a possible fire, do not block air intake or exhaust in any manner.
- ⑬ All electrical heaters have hot and arcing or sparking parts inside. Do not use in areas where

IMPORTANT INSTRUCTIONS

gasoline, paint, or flammable liquids are used or stored.

⑭ Do not modify the electric fireplace. Use it only as described in this manual. Any other use not recommended by the manufacturer may cause fire, electric shock or injury to persons.

⑮ Always plug heaters directly into a wall outlet/receptacle. Never use with an extension cord or relocatable power tap (outlet/power strip).

⑯ Do not burn wood or other materials in the electric fireplace.

⑰ Do not strike the fireplace glass.

⑱ Always use a certified electrician should new circuits or outlets be required.

⑲ Always use properly grounded, fused and polarized outlets.

⑳ Disconnect all power supply before performing any cleaning, maintenance or relocation of the unit.

㉑ When transporting or storing the unit and cord, keep in a dry place, free from excessive vibration and store so as to avoid damage.

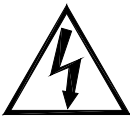

CAUTION
RISK OF ELECTRIC SHOCK
DO NOT OPEN
NO USER-SERVICABLE PARTS INSIDE



SAVE THESE INSTRUCTIONS

IMPORTANT INSTRUCTIONS

 CAUTION: This equipment has been tested and found to comply with the limits for a Class B digital device, pursuant to Part 15 of the FCC Rules. These limits are designed to provide reasonable protection against harmful interference in a residential installation. This equipment generates uses and can radiate radio frequency energy and, if not installed and used in accordance with the instructions, may cause harmful interference to radio communications. However, there is no guarantee that interference will not occur in a particular installation. If this equipment does cause harmful interference to radio or television reception, which can be determined by turning the equipment off and on, the user is encouraged to try to correct the interference by one of the following measures:

- Reorient or relocate the receiving antenna.
- Increase the separation between the equipment and receiver.
- Connect the equipment into an outlet on a circuit different from that to which the receiver is connected.
- Consult the dealer or an experienced radio/TV technician for help.

This device complies with Part 15 of the FCC Rules. Operation is subject to the following two conditions: (1) This device may not cause harmful interference, and (2) this device must accept any interference received, including interference that may cause undesired operation.

 FCC CAUTION: Any changes or modifications not expressly approved by the party responsible for compliance could void the user's authority to operate this equipment.

This device complies with Industry Canada licence-exempt RSS standard(s). Operation is subject to the following two conditions: (1) this device may not cause interference, and (2) this device must accept any interference, including interference that may cause undesired operation of the device.

Under Industry Canada regulations, this radio transmitter may only operate using an antenna of a type and maximum (or lesser) gain approved for the transmitter by Industry Canada. To reduce potential radio interference to other users, the antenna type and its gain should be so chosen that the equivalent isotropically radiated power (e.i.r.p.) is not more than that necessary for successful communication.

 WARNING: Remote control contains small batteries. Keep away from children. If swallowed, seek medical attention immediately.

 WARNING: Do not install battery backwards, charge, put in fire or mix with used or other battery types - may explode or leak causing injury.

! NOTE: Changes or modifications not expressly approved by the party responsible for compliance could void user's authority to operate the equipment.

Fireplace Installation

⚠ WARNING: Ensure the power cord is not installed so that it is pinched or against a sharp edge and ensure that the power cord is stored or secured to avoid tripping or snagging to reduce the risk of fire, electric shock or injury to persons.

⚠ WARNING: Construction and electrical outlet wiring must comply with local building codes and other applicable regulations to reduce the risk of fire, electric shock and injury to persons.

⚠ WARNING: Do not attempt to wire your own new outlets or circuits. To reduce the risk of fire, electric shock or injury to persons, always use a licensed electrician.

⚠ WARNING: To reduce the risk of fire, do not store or use gasoline or other flammable vapors or liquids in the vicinity of the heater.

⚠ CAUTION: Clearance for air circulation beneath the fireplace insert is provided by two (2) rubber feet.

Do not install the fireplace insert directly on carpet or similar surfaces which may restrict air circulation.

⚠ CAUTION: If installing the

fireplace in a carpeted area, place a one-piece, solid, flat surface under the fireplace insert. Ensure that both of the insert's feet rest securely on this surface.

! NOTE: The dimensions of the fireplace are 31 ½ in. (800 mm) wide x 22 ¾ in. (568 mm) high x 9 ½ in. (232 mm) deep. The fireplace does not require any additional venting.

Mantel Installation

Install the fireplace assembly into the mantel (refer to mantel assembly instructions).

! IMPORTANT: If not using a Dimplex mantel, the fireplace must be installed in an enclosure with the following **minimum** inter-

Figure 1

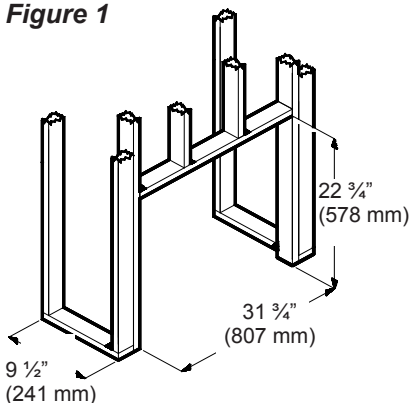

Fireplace Installation

nal/opening dimensions (Figure 1).

New Wall Construction

1. Mark the desired location on the floor and store the fireplace in a safe, dry and dust free location.
2. Use studs to frame an opening of 31 $\frac{3}{4}$ in. (807 mm) wide x 22 $\frac{3}{4}$ in. (578 mm) high x 9 $\frac{1}{2}$ in. (241 mm) deep.

Option #1 - The power cord can be lead from behind the trim and along the wall to an outlet near the fireplace.

Option #2 - A new outlet can be installed inside the new frame construction. Plug the unit into a 15 Amp, 120 Volt outlet.

! NOTE 1: A 15 Amp, 120 Volt circuit is required. A dedicated circuit is preferred but not essential in all cases. A dedicated circuit will be required if, after installation, the circuit breaker trips or fuse blows on a regular basis when the heater is operating. Additional appliances on the same circuit may exceed the current rating of the circuit breaker.

Option #3 - Hardwire

1. Wire a dedicated, properly

fused circuit with 120 Volt, 15 Amp rating. Allow up to 8 ft. (2.4 m) of service cable for connecting power supply to junction box on fireplace when installing after finishing wall.

! CAUTION: Use two conductor, non-metallic sheath cable with ground wire (three wires total) for the incoming power supply on fireplace inserts. Use appropriate wire to meet local and national

Figure 2

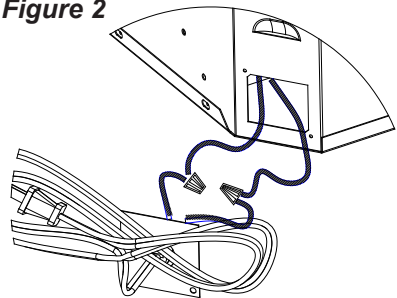
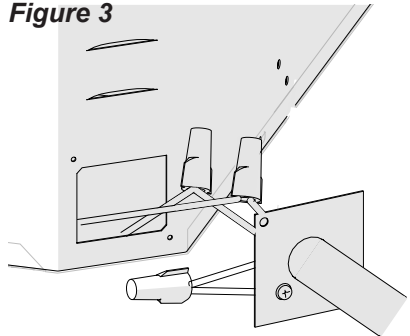

Figure 3



Fireplace Installation

electrical codes for rated power consumption.

2. Remove the outer jacket and strip the individual conductor from the end.
3. Loosen the screw securing the junction box cover and remove the cover.
4. Take the cables out from the junction box, loosen the two wire twist nuts and remove the power cord (Figure 2).
5. Route the power supply wire through the knockout on supplied alternative junction box cover and secure with a wire clamp (not supplied) (Figure 3).
6. Connect the black wire (line) from the unit to the line wire from power supply (Figure 3).
7. Connect the white wire (neutral) from the unit to the neutral wire from power supply (Figure 3).
8. Connect the ground wire from the power supply to the ground wire on the junction box cover (Figure 3).
9. Place all connectors inside the unit and secure the junction box cover to unit. Ensure that the cable clamp grips only the jacket of service cable.

Final Steps

Carefully pour and evenly distribute the supplied glass rock media on the front tray of the firebox (Figure 4). Once complete, hang the front glass assembly on the mounts of the firebox.

Wiring

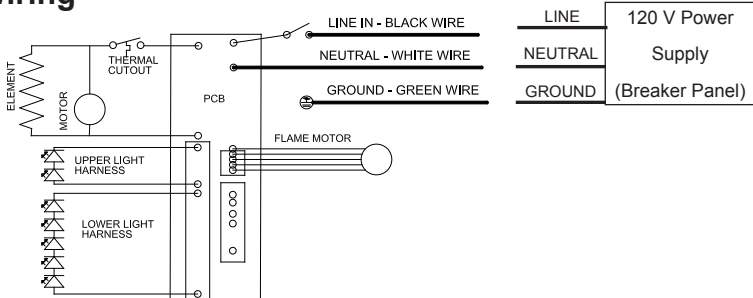

Fireplace Installation

Figure 4

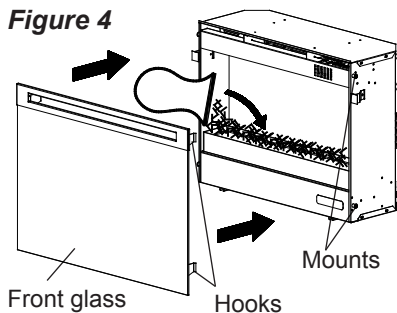

Operation

Figure 5

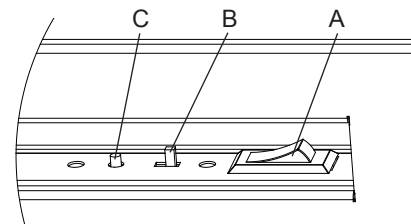

⚠ WARNING: This electric firebox must be properly installed before it is used.

Manual Controls

The manual controls for the fireplace are located in the upper right hand corner (Figure 5).

A. Main On/Off Switch

Supplies power to the 3 Position Manual Control Switch.

B. 3 Position Manual Control Switch

Remote (left position): The unit is operated with the remote control.

Flame (center position): The flame effect is turned on.

Flame & Heat (right position): The flame effect and heater are turned on simultaneously. When the manual control is in the **Flame & Heat** position the heater does not run on the remote operated thermostat.

! NOTE: When the manual control switch is in the **Flame** or **Flame & Heat** positions, the fireplace unit will not operate with the remote control.

Operation

C. Initialization Button

Used to synchronize the remote control with the fireplace.

! NOTE: The heater on your fireplace may emit a slight, harmless odor when first used. This odor is a normal condition caused by the initial heating of internal heater parts and will not occur again.

Resetting the Temperature Cutoff Switch

Should the heater overheat, an automatic switch will turn the heater off and it will not come back on without being reset. The temperature cutoff switch can be reset by unplugging the unit, waiting five minutes and plugging the unit back in.

! CAUTION: If you need to continuously reset the heater,

unplug the unit and call Dimplex North America Limited at 1-888-346-7539 for technical support. Please have your model and serial number ready when calling.

Remote Control

The remote control has a range of approximately 50 feet (15.25 m), it does not have to be pointed at the fireplace and can pass through most obstacles (including walls). It is supplied with 243 independent frequencies to prevent interference with other units.

Battery Installation

1. Depress tab on the battery cover on the back of the remote control and remove battery cover (Figure 6).
2. Install two AAA batteries into the remote control (included).
3. Ensure child lock is in the “unlocked” position (Figure 6).
4. Replace the battery cover.

! NOTE: When the “BAT” symbol is present on the remote control it is recommended to replace the batteries promptly, to maintain full functionality of the remote/fireplace. The

Figure 6

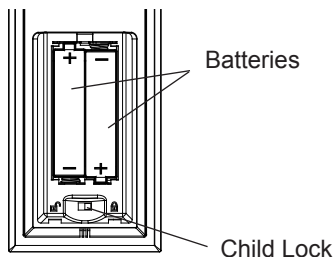

Operation



remote control has a battery backup time of only several hours.



Battery must be recycled or disposed of properly. Check with your Local

Authority or Retailer for recycling advice in your area.

Initializing/Reprogramming the Remote Control

1. Plug cord into 120 Volt wall outlet.
2. Ensure the Main On/Off Switch located in the switch box on the fireplace in the upper right hand corner is in the **— ON** position (Figure 5A).
3. Set the 3 Position Manual Control (Figure 5B) to the **Remote** position (left position).
4. Press and hold the Initialization Button on the unit (Figure 5C).
5. While holding the Initialization Button, press the Flame/Heat On/Off  button on the remote control.
6. Release the Initialization Button on the unit.
7. Press the Flame/Heat On/Off button  to turn the Flame/

Heat function on.

Frequency Interference

If the fireplace does not respond properly to the remote control, the remote operating frequency may have to be reset. The remote control can send another frequency code to the circuit board to eliminate interference.

1. Simultaneously press the **“Temperature Down”** button and the **“Flame Speed Down”** button on the remote control (Figure 7).
2. **“COD”** will appear in place of the sleep timer digits.
3. Release the **“Temperature Down”** button and the **“Flame Speed Down”** button.
4. Press the Initialization Button on the unit (Figure 5C).
5. Press the Flame/Heat On/Off Button  button on the remote.

Your remote will now have a different frequency communicating with the fireplace.

Operation

Figure 7 - Remote Control Functions

- A. Room Temperature
- B. Set Temperature
- C. Dimmer
- D. Flame Speed Control
- E. Sleep Timer
- F. Flame & Heat On/Off
- G. Temperature Down
- H. Temperature Up
- I. Dimmer Down
- J. Dimmer Up
- K. Flame Speed Down
- L. Flame Speed Up
- M. Sleep Timer Down
- N. Sleep Timer Up

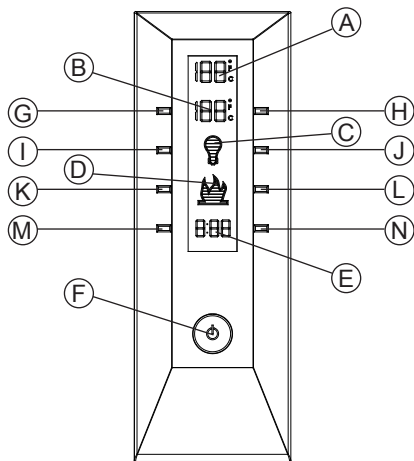

Remote Control Functions

(All letter references are to Figure 7)

B. Set Temperature

Press **F** button  to turn fireplace on.

Press **H** to raise thermostat.

Press **G** to lower thermostat.

Press both **H** and **G** to change °F to °C.

C. Dimmer

Press the **F** button  to turn the Flame/Heat on.

Repeatedly press the **J** or **I**

button to decrease or increase the brightness of the upper lights.

D. Flame Speed

Press the **F** button  to turn the Flame/Heat on.

Press the **L** button to increase the speed of the flame.

Press the **K** to decrease the speed of the flame.

E. Sleep Timer

The Sleep Timer automatically shuts off the fireplace after a

Operation

preset time (from 30 minutes to 8 hours).

Press the **F** button  to turn the fireplace on.

To set the sleep timer press the **N** button.

Set the timer from 30 minutes through 8 hours. The fireplace will automatically turn off when the sleep timer reaches zero (0) minutes.

The Sleep Timer can be cancelled at any time by pressing the **M** button repeatedly until the sleep timer displays nothing.

 **WARNING:** Disconnect power before attempting any maintenance or cleaning to reduce the risk of fire, electric shock or damage to persons.

F. Flame & Heat On/Off Button

Press the **F** button  to turn the Flame/Heat function on. When **B** is higher than **A** the heat will come on. To turn the heat off, lower the **B** so that its setting is lower than the **A**. The default temperature setting is 72°F (22°C).

! NOTE: When using the

remote control the heater runs on a thermostat. Press the **H** or **G** buttons to adjust the set temperature. Once the desired set temperature is reached the heater will turn off. The heater will cycle on and off to maintain the desired set temperature.

Disable Heat

If desired, depending on the season, the heater on the unit can be disabled. The unit will operate in the same fashion, with remainder of the controls.

To Disable - Press **M** and **H** at the same time. The temperature setting on the remote will no longer be visible.

! NOTE: The heat will not work in manual controls either.

To Enable - Press **I** and **K** at the same time. The temperature setting will now be visible again.

Operation

Child Lock (Figure 8)

1. Depress tab on the battery cover on the back of the remote control and remove the battery cover (Figure 6).
2. Move **Child Lock** tab to the right to lock the remote control.
3. Move **Child Lock** tab back to the left to unlock the remote control.
4. Replace the battery cover.

! NOTE: To temporarily unlock the remote control press (in order) **G** then **H** then **I**.

When the remote control's backlight is illuminated the **Child Lock** is bypassed. When the backlight is off the **Child Lock** is re-activated.

Figure 8

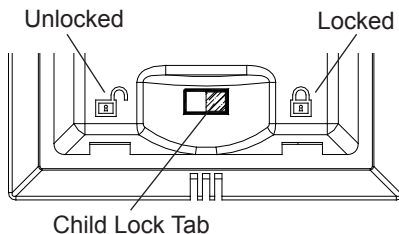



Maintenance

⚠ WARNING: Disconnect power before attempting any maintenance or cleaning to reduce the risk of fire, electric shock or damage to persons.

! NOTE: The fireplace should not be operated with an accumulation of dust or dirt on or in the unit, as this can cause a build up of heat and eventual damage. For this reason the heater must be inspected regularly, depending upon conditions and at least at yearly intervals.

Glass Cleaning

The glass is cleaned in the factory during the assembly operation. During shipment, installation, handling, etc., the glass may collect dust particles; these can be removed by dusting lightly with a clean dry cloth.

To remove fingerprints or other marks, the glass can be cleaned with a damp cloth. To prevent scratching, do not use abrasive cleaners or spray liquids on the glass surface.

Fireplace Surface Cleaning

Use a cloth dampened with warm water only to clean painted surfaces of the electric fireplace. Do not use abrasive cleaners.



Warranty

Products to which this limited warranty applies

This limited warranty applies to the following model of your newly purchased Dimplex electric fireplace **DFG3033** and to newly purchased Dimplex fireplace surrounds (mantels) and trims. This limited warranty applies only to purchases made in any province of Canada except for Yukon Territory, Nunavut, or Northwest Territories or in any of the 50 States of the USA (and the District of Columbia) except for Hawaii and Alaska. This limited warranty applies to the original purchaser of the product only and is not transferable.

Products excluded from this limited warranty

Products purchased in Yukon Territory, Nunavut, Northwest Territories, Hawaii, or Alaska are not covered by this limited warranty. Products purchased in these States, provinces, or territories are sold AS IS without warranty or condition of any kind (including, without limitation, any implied warranties or conditions of merchantability or fitness for a particular purpose) and the entire risk of as to the quality and performance of the products is with the purchaser, and in the event of a defect the purchaser assumes the entire cost of all necessary servicing or repair.

What this limited warranty covers and for how long

Products, other than fireplace surrounds (mantels) and trims, covered by this limited warranty have been tested and inspected prior to shipment. Subject to the provisions of this warranty, Dimplex warrants such products to be free from defects in material and workmanship for a period of 5 years from the date of the first purchase of such products as follows: (a) a repair or replacement warranty on defective products or parts, including in-home

services, for the first 1 year following the date of first purchase; and (b) thereafter, a replacement of parts warranty on defective products and parts (with no in-home services) for the 4 year period commencing on the second anniversary of first purchase and ending on the fifth anniversary of the date of first purchase.

Dimplex fireplace surrounds (mantels) and trims covered by this limited warranty have been tested and inspected prior to shipment and, subject to the provisions of this warranty, Dimplex warrants such products to be free from defects in material and workmanship for a period of 1 year from the date of first purchase of such products. Warranty services do not include in-home services.

The above section is a summary only of your warranty rights. Please review the remaining provisions of this warranty for your specific rights.

The limited 5 year warranty period for products other than fireplace surrounds (mantels) and trims and the limited 1 year warranty period for fireplace surrounds (mantels) and trims also applies to any implied warranties that may exist under applicable law. Some jurisdictions do not allow limitations on how long an implied warranty lasts, so the above limitation may not apply to the purchaser.

What this limited warranty does not cover

This limited warranty does not apply to products that have been repaired (except by Dimplex or its authorized service representatives) or otherwise altered. This limited warranty does further not apply to defects resulting from misuse, abuse, accident, neglect, incorrect installation, improper maintenance or handling, or operation with an incorrect power source.

What you must do to get service under this limited warranty



Warranty

Defects must be brought to the attention of Dimplex Technical Service by contacting Dimplex at 1-888-DIMPLEX (1-888-346-7539), or 1367 Industrial Road, Cambridge Ontario, Canada N1R 7G8. Please have proof of purchase, catalogue/model and serial numbers available when calling. Limited warranty service requires a proof of purchase of the product.

What Dimplex will do in the event of a defect

In the event a product or part covered by this limited warranty is proven to be defective in material or workmanship during (i) the 5 year limited warranty period for products other than fireplace surrounds (mantels) and trims, and (ii) the 1 year limited warranty period for surrounds (mantels) and trims, you have the following rights:

- Limited warranty service will be performed solely by dealers or service agents of Dimplex authorized to provide limited warranty services.
- **For products (other than surrounds (mantels) and trims) for the period ending at midnight on the first anniversary of the date of first purchase**, Dimplex will in its sole discretion either repair or replace such defective product or part without charge. If Dimplex is unable to repair or replace such product or part, or if repair or replacement is not commercially practicable or cannot be timely made, Dimplex may, in lieu of repair or replacement, choose to refund the purchase price for such product or part. This limited warranty entitles the purchaser to on-site or in-home warranty services. Accordingly, Dimplex will be responsible for all labour and transportation costs associated with the repair or replacement of the product or part except as follows: (i) charges may be levied for travel costs

incurred to travel to the purchaser's site where the product is located if the purchaser's site is beyond 30 miles (48 km) from the closest service depot of Dimplex's dealer or service agent; and (ii) the purchaser is solely responsible for providing clear access to all serviceable parts of the product.

- **For products (other than surrounds (mantels) and trims) for the period commencing at 12:01 a.m. on the day after the first anniversary of the first purchase and ending at midnight on the fifth anniversary of the date of first purchase**, this limited warranty entitles the purchaser to replacement parts only without charge. If Dimplex is unable to replace such part, or if replacement is not commercially practicable or cannot be timely made, Dimplex may, in lieu of replacement, choose to refund the purchase price for such part. The purchaser shall not be entitled to on-site or in-home warranty services. The purchaser shall be responsible for all expenses incurred for the removal of the part and installation of the replacement part including, without limitation, all shipping costs and transportation costs to and from the authorized dealer's or service agent's place of business and all labour costs. Such costs shall not be the responsibility of Dimplex.
- **For surrounds (mantels) and trims for the period ending at midnight on the first anniversary of the date of first purchase**, Dimplex will in its sole discretion either repair or replace such defective surrounds (mantels) and trims or part thereof without charge. If Dimplex is unable to repair or replace such product or part, or if repair or replacement is not commercially practicable or cannot be timely made, Dimplex



Warranty

may, in lieu of repair or replacement, choose to refund the purchase price for such product or part. The purchaser shall not be entitled to on-site or in-house services. The purchaser is responsible for all expenses incurred for repair or replacement of such product or part including, without limitation, all shipping costs and transportation costs to and from the authorized dealer's or service agent's business and all labour costs. Such costs shall not be the responsibility of Dimplex.

- On-site or in-home services not provided under this warranty may be performed at the purchaser's specific request and expense at Dimplex's then-current rates for such services.

What Dimplex and its dealers and service agents are also not responsible for:

IN NO EVENT WILL DIMPLEX, OR ITS DIRECTORS, OFFICERS, OR AGENTS, BE LIABLE TO THE PURCHASER OR ANY THIRD PARTY, WHETHER IN CONTRACT, IN TORT, OR ON ANY OTHER BASIS, FOR ANY INDIRECT, SPECIAL, PUNITIVE, EXEMPLARY, CONSEQUENTIAL, OR INCIDENTAL LOSS, COST, OR DAMAGE ARISING OUT OF OR IN CONNECTION WITH THE SALE, MAINTENANCE, USE, OR INABILITY TO USE THE PRODUCT, EVEN IF DIMPLEX OR ITS DIRECTORS, OFFICERS, OR AGENTS HAVE BEEN ADVISED OF THE POSSIBILITY OF SUCH LOSSES, COSTS OR DAMAGES, OR IF SUCH LOSSES, COSTS, OR DAMAGES ARE FORESEEABLE. IN NO EVENT WILL DIMPLEX, OR ITS OFFICERS, DIREC-

TORS, OR AGENTS BE LIABLE FOR ANY DIRECT LOSSES, COSTS, OR DAMAGES THAT EXCEED THE PURCHASE PRICE OF THE PRODUCT.

SOME JURISDICTIONS DO NOT ALLOW THE EXCLUSION OR LIMITATION OF INCIDENTAL OR CONSEQUENTIAL DAMAGES, SO THE ABOVE LIMITATION OR EXCLUSION MAY NOT APPLY TO THE PURCHASER.

How State and Provincial law apply

This limited warranty gives you specific legal rights, and you may also have other rights which vary from jurisdiction to jurisdiction. The provisions of the United Nations Convention on Contracts for the Sale of Goods shall not apply to this limited warranty or the sale of products covered by this limited warranty.

Replacement Parts List

Flicker Motor	3000240200KIT
Heater Assembly (with cutout)	2000330200RP
On/Off Switch	2800070200RP
Power Cord	4100040300RP
Upper LED Light	2500730100RP
Lower LED Light	3001210100RP
Partially Reflective Glass.	5900910100RP
Front Glass	1015270159RP
Remote Control	3001070100RP
Remote Control Receiver	3001200100RP
Remote Switchboard	3000300300RP
Flicker Rod	5901250100RP



Dimplex North America Limited
1367 Industrial Road
Cambridge ON
Canada N1R 7G8

© 2013 Dimplex North America Limited